

Japanese Book Binding



Materials:

- ▶ 1 arm length thread (1 yard)
- ▶ 10 sheets paper for pages (folded in half)
- ▶ 2 sheets decorative paper for cover.



Tools:

- 1 needle
- 1 punch (awl)
- Scissors
- Hole punch guide
- Binder clip
- pencil



To “smell” or “dab” a yard

Extend arm straight out. Turn head opposite of extended arm. Bring end of thread up to nose, pulling thread tight to other hand.

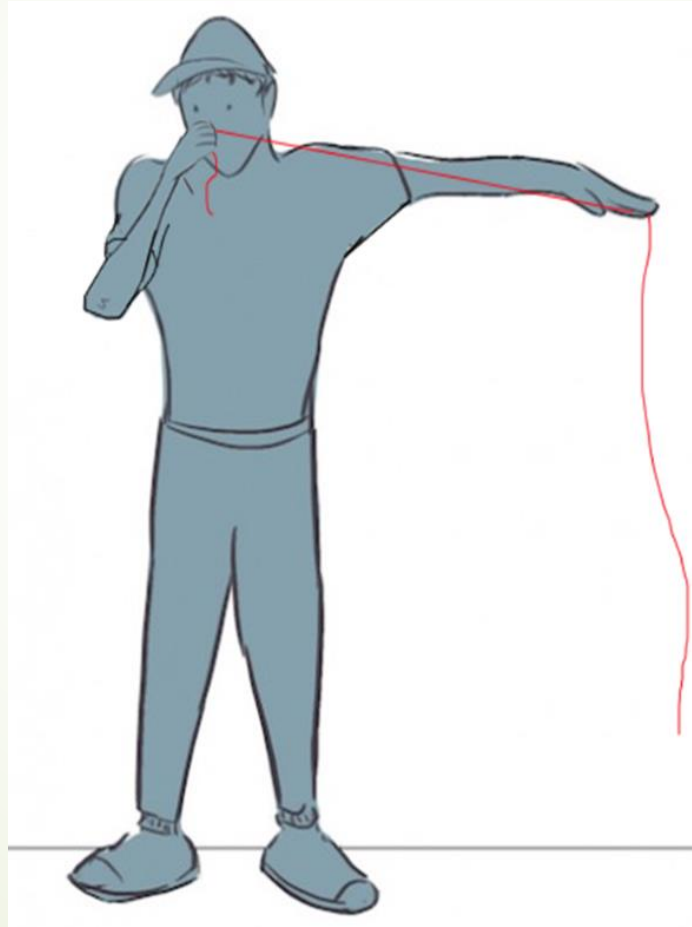



Sewing Basics:

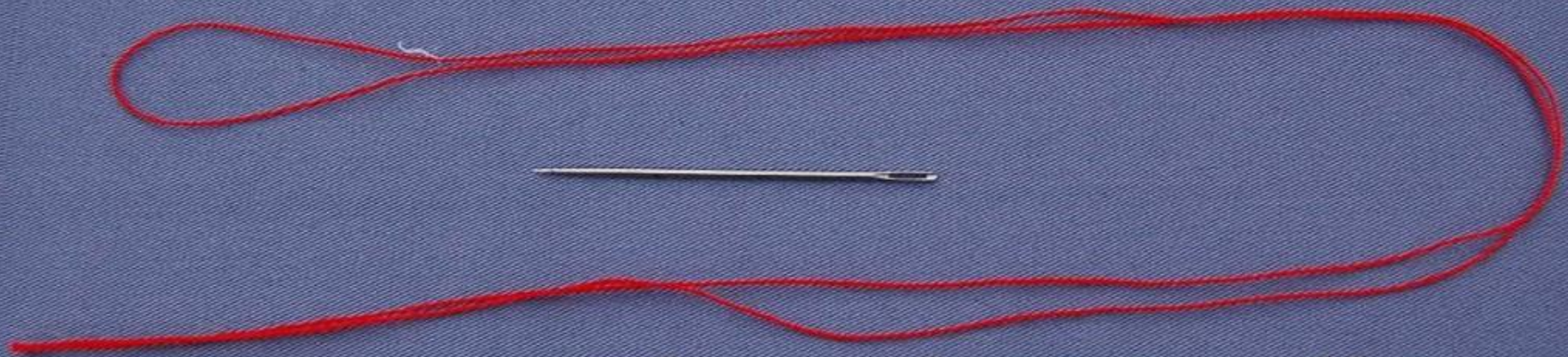

**How to Thread a Needle
& Tie a Knot {Quickly!}**

Chicken Scratch NY

Thread the Needle

- Start with a length of thread, fold it over and pull the thread down between your fingers until you get a small loop at the top sandwiched between your fingers. Thread the needle with this loop.

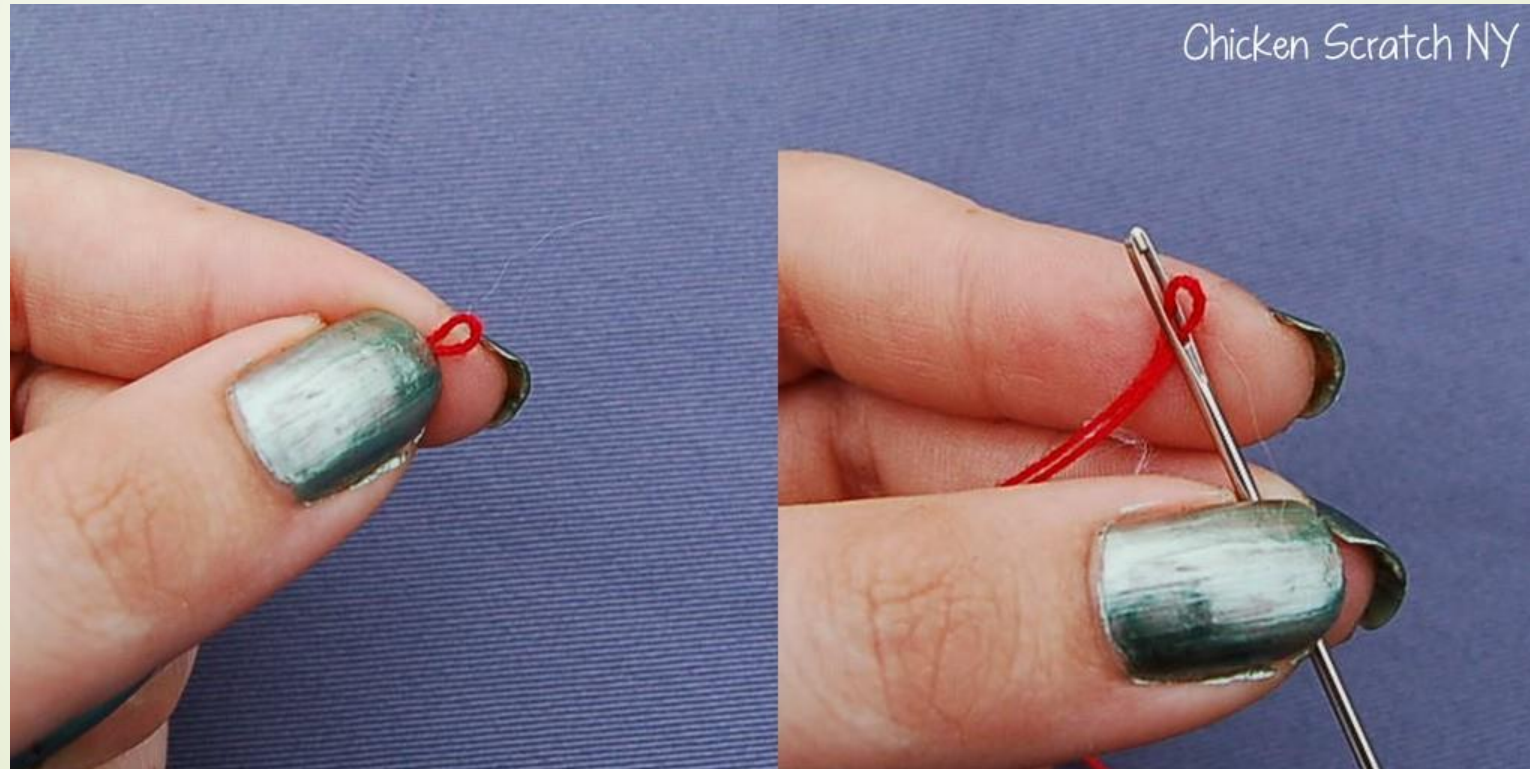

Thread the Needle

- Wrap all the strands of thread around your index finger in a loop. Pinch your index finger and thread together and roll your thumb down your finger, the thread will roll into a knot.

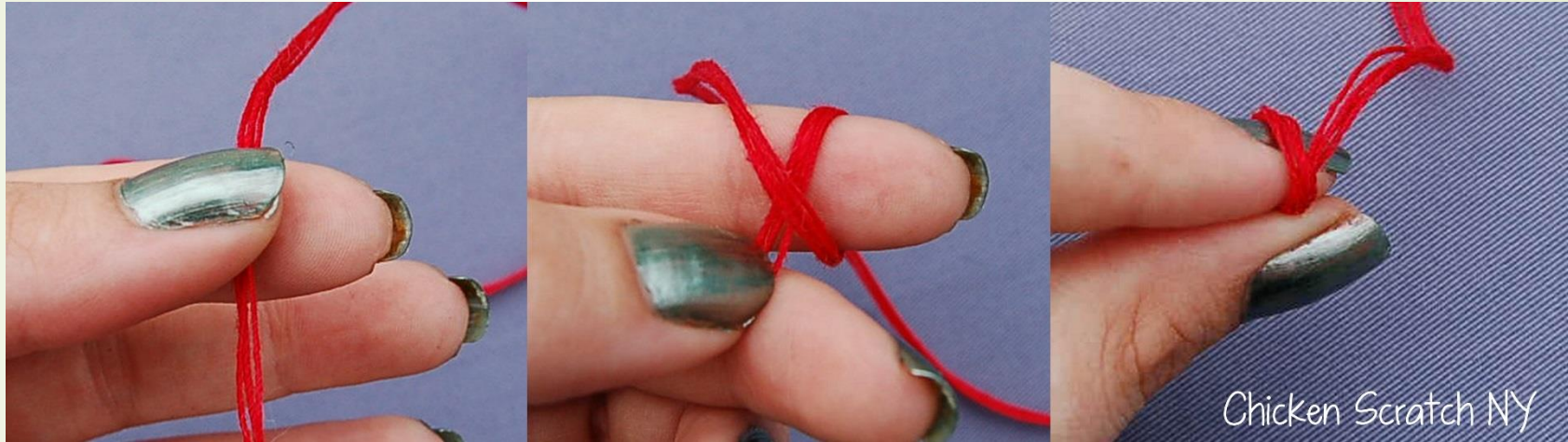

Thread the Needle

- ▶ Pull it tight using your thumb nail against your finger.



Book Binding

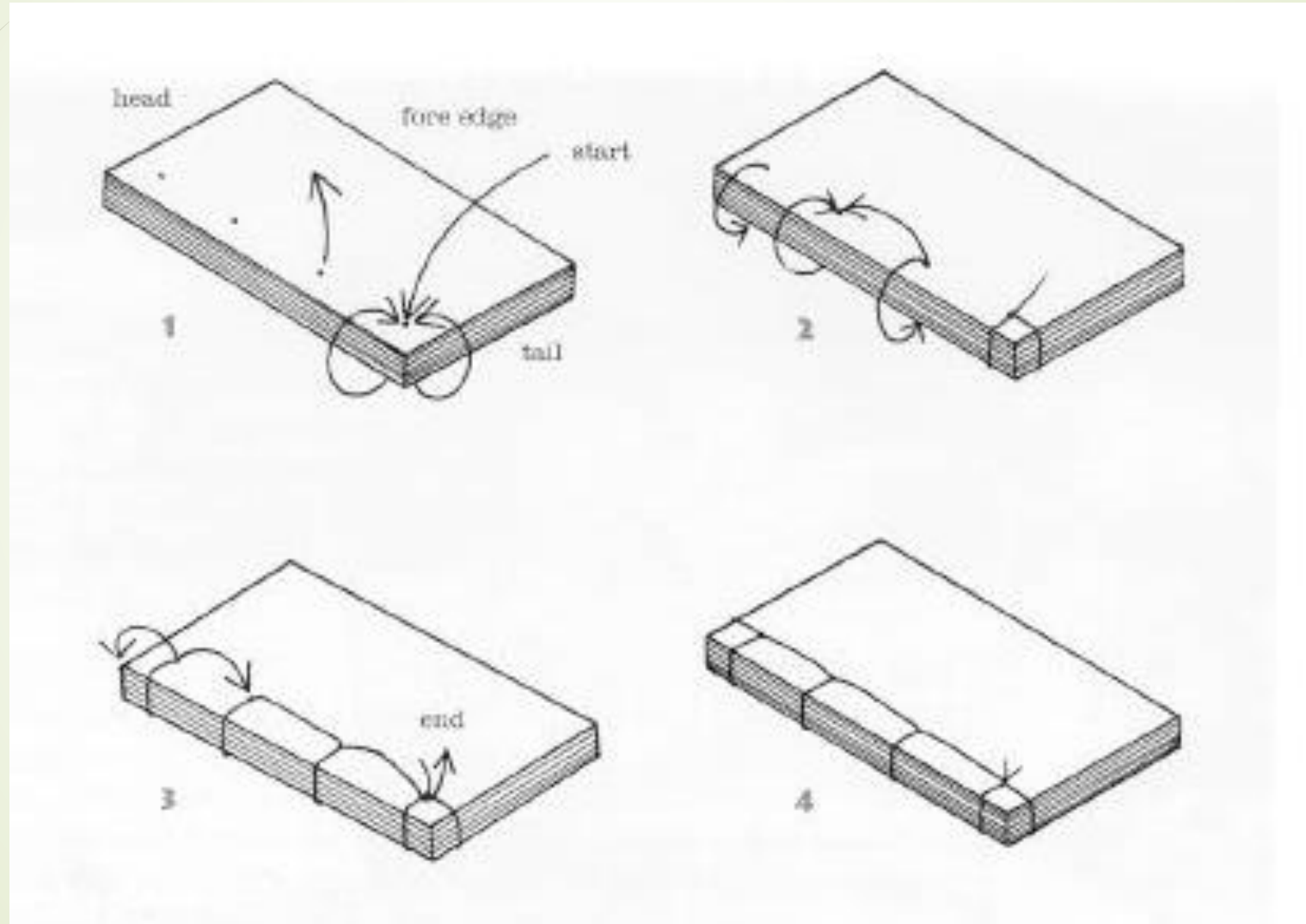

Book Binding

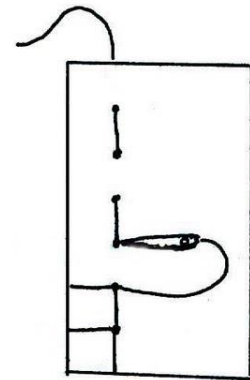
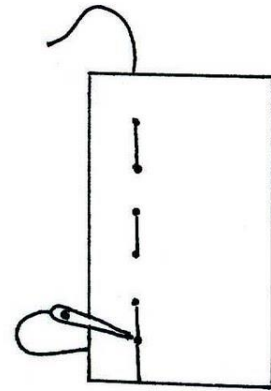
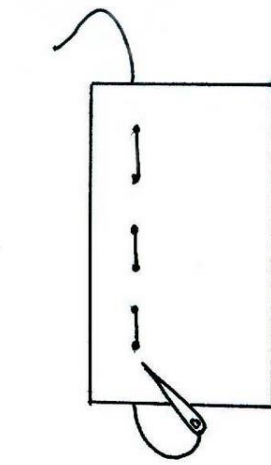

Japanese Book Binding

4



FOUR HOLE BINDING

This illustration is to scale. With a ruler, measure off this illustration and mark the front, outside cover with sewing holes.

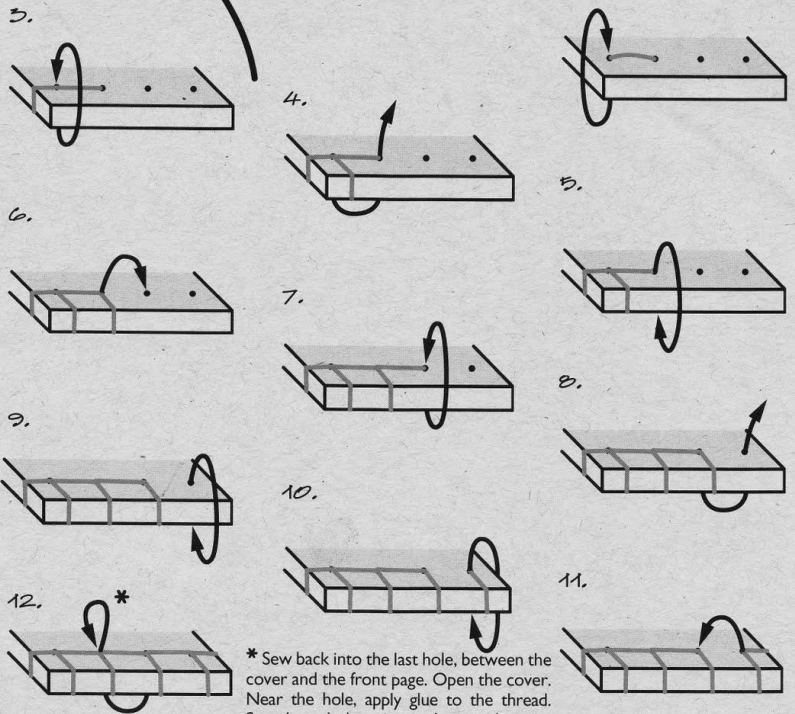
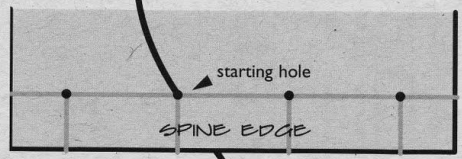

* Sew back into the last hole, between the cover and the front page. Open the cover. Near the hole, apply glue to the thread. Sew through the spine to the outside, spine edge. Trim and tuck the gluey thread end into the spine.



© 1999 Books By Hand

Bind the Book

▶ Step 1

- ▶ Cut an arm's length of linen thread. Hold the book up with the spine facing you. For the purpose of this tutorial, the four holes will be numbered 1 to 4, starting from the left. Sew the thread up through hole number 3.



Bind the Book

- ▶ Leave a tail of at least 2 inches sticking out.



Bind the Book

▶ Step 2

- ▶ Sew up through hole number 3 once more to make a loop around the spine.



Bind the Book

- ▶ Pull the stitch tight.

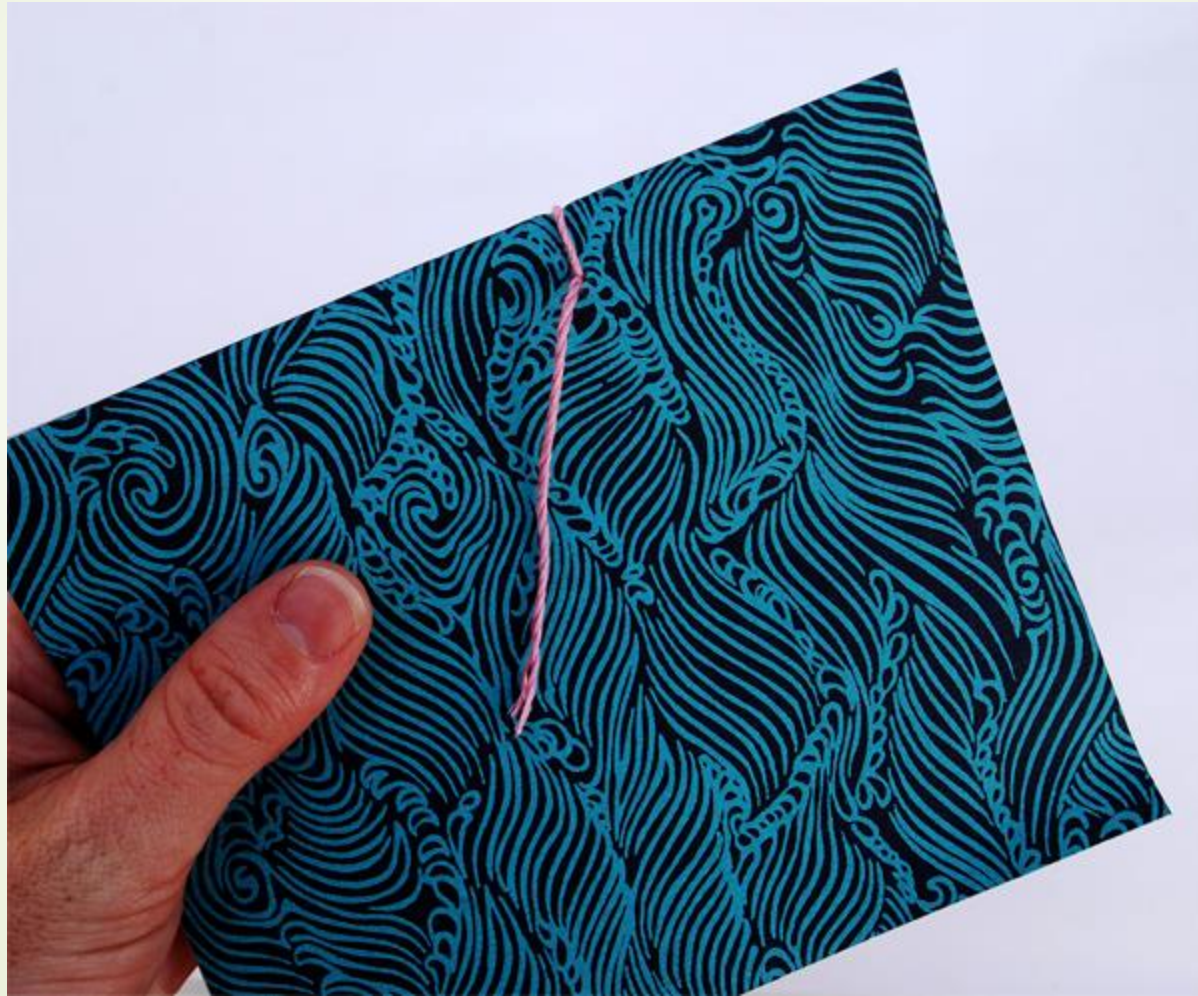

Bind the Book

- ▶ **Step 3**
- ▶ Stitch down through hole number 2.

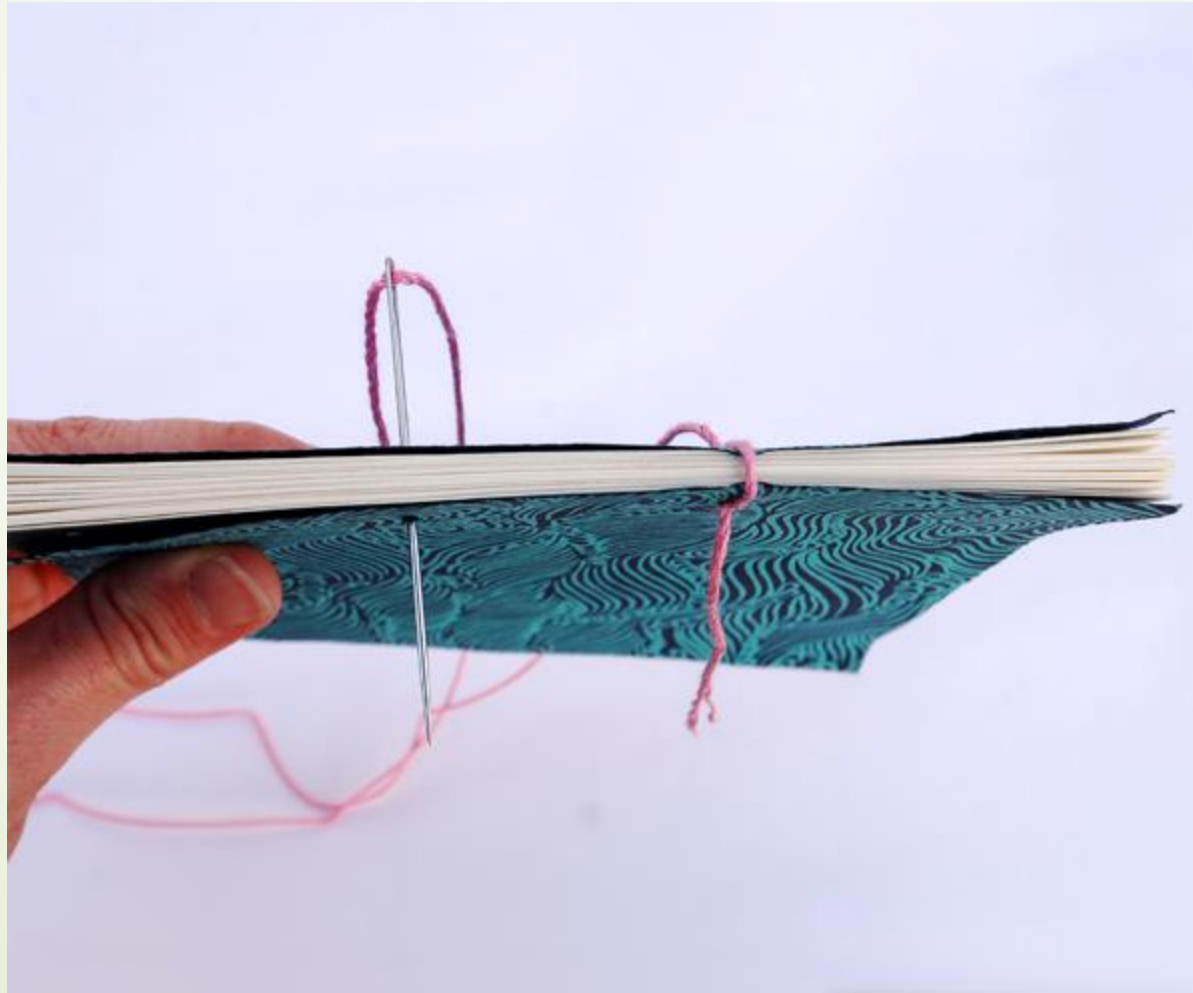

Bind the Book

▶ Step 3

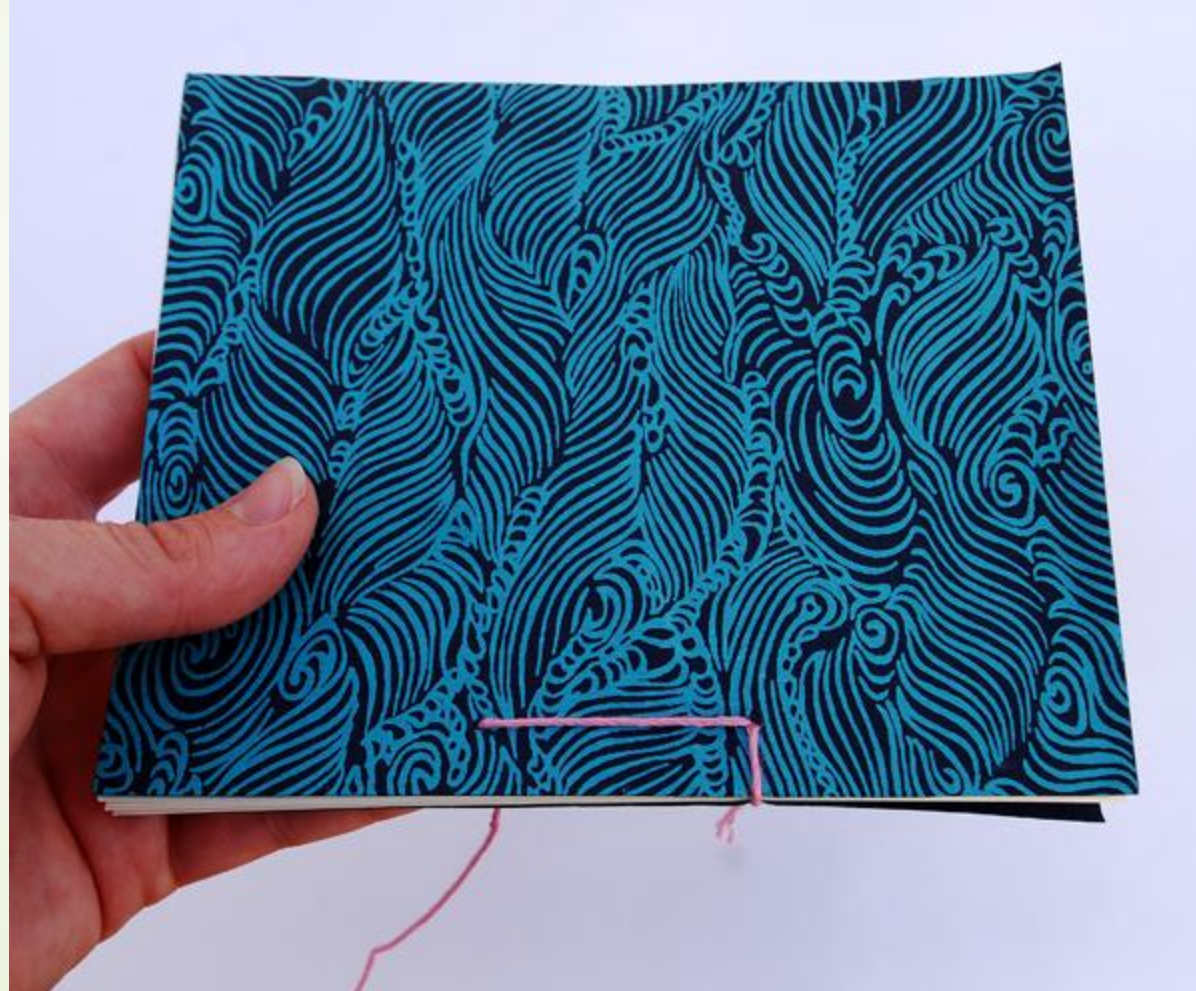

Bind the Book

➤ Step 4

- Stitch down through hole number 2 a second time to make a loop.

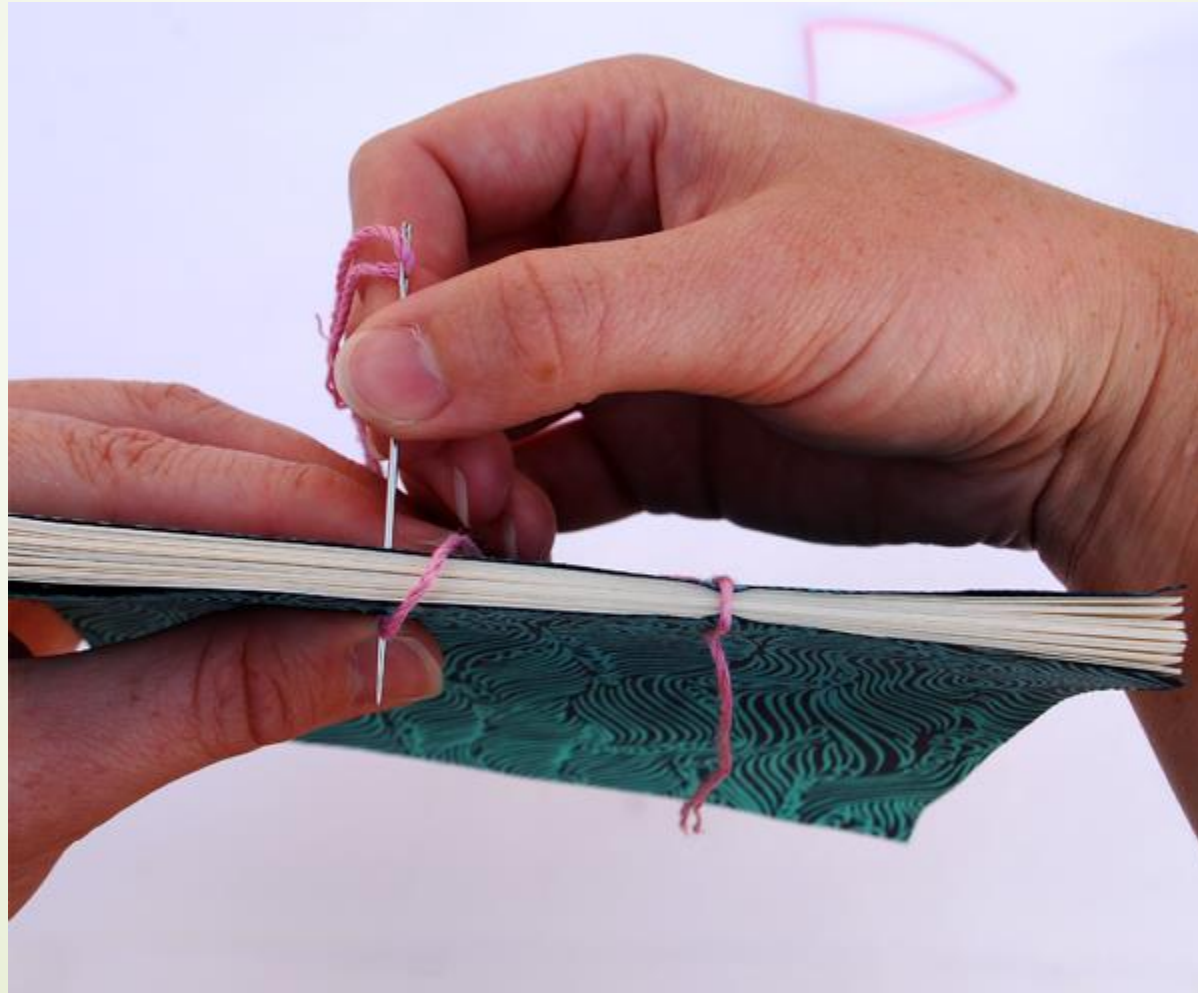

Bind the Book

- ▶ **Step 5**
- ▶ Sew up through hole number 1.



Bind the Book

▶ Step 6

- ▶ Make that loop by stitching up through hole number 1 again.

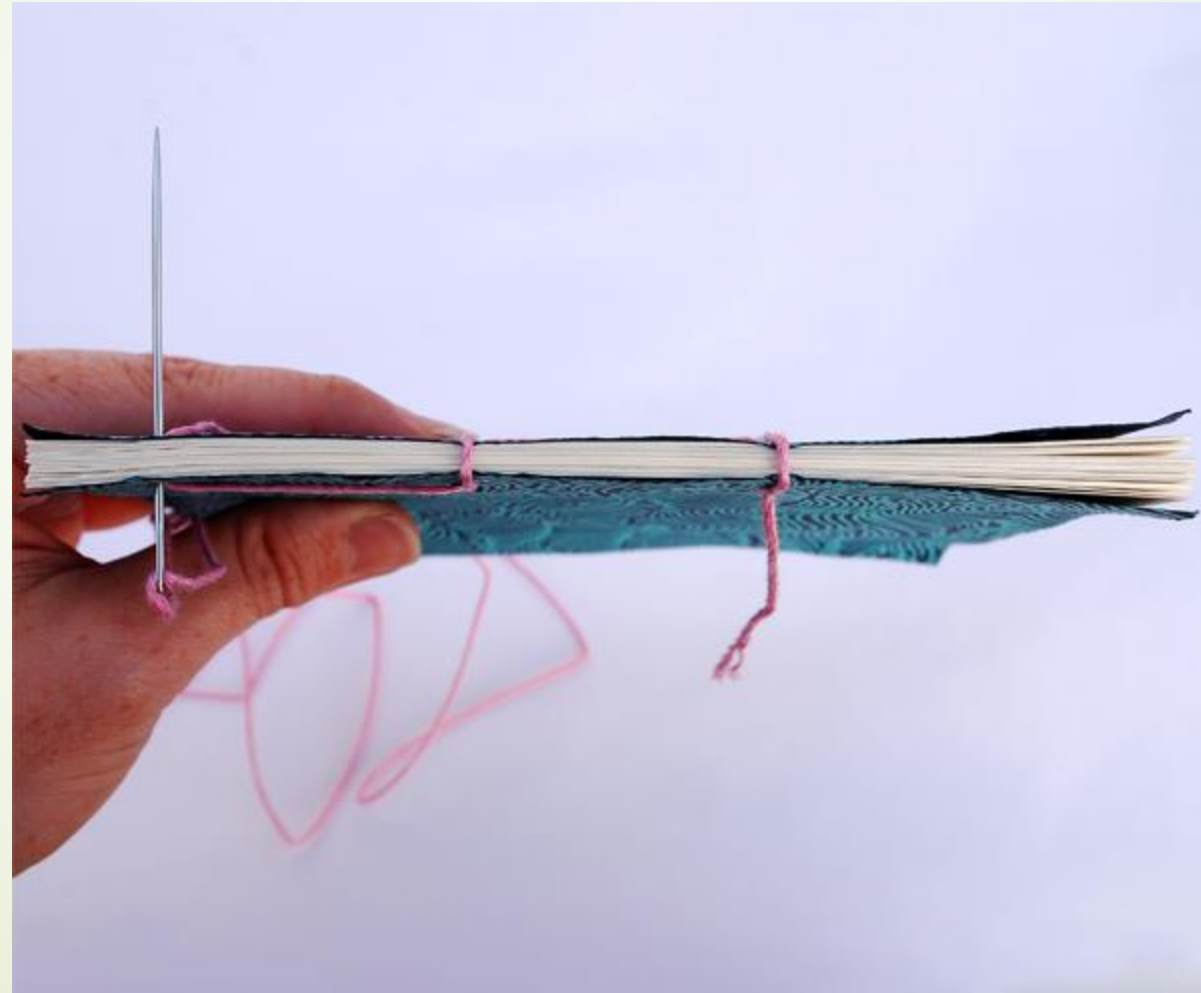

Bind the Book

▶ Step 6



Bind the Book

▶ Step 7

- ▶ At the end of the binding, you will want to make a second loop to secure the pages. Sew up through hole number 1 one last time and position the loop so that it lines up with the four holes.

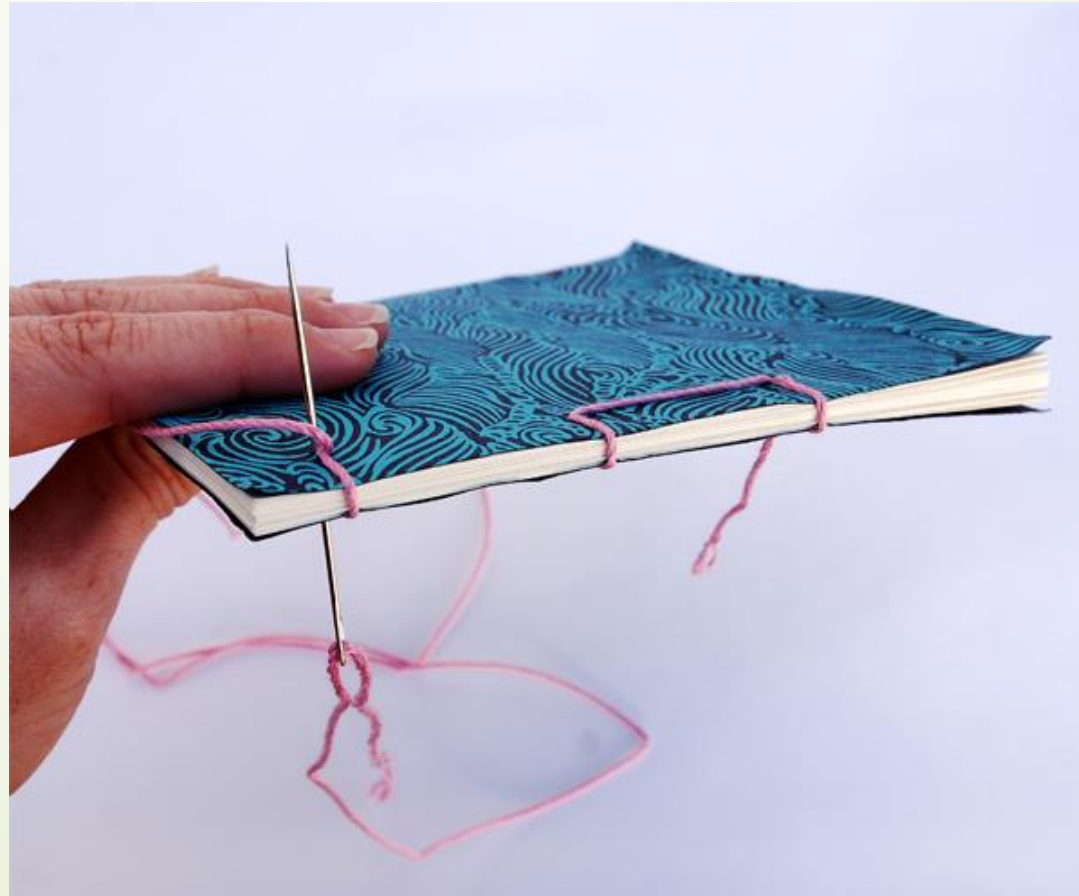

Bind the Book

- ▶ **Step 8**
- ▶ Sew down through hole number 2.



Bind the Book

- ▶ **Step 9**
- ▶ Then sew up through hole number 3.

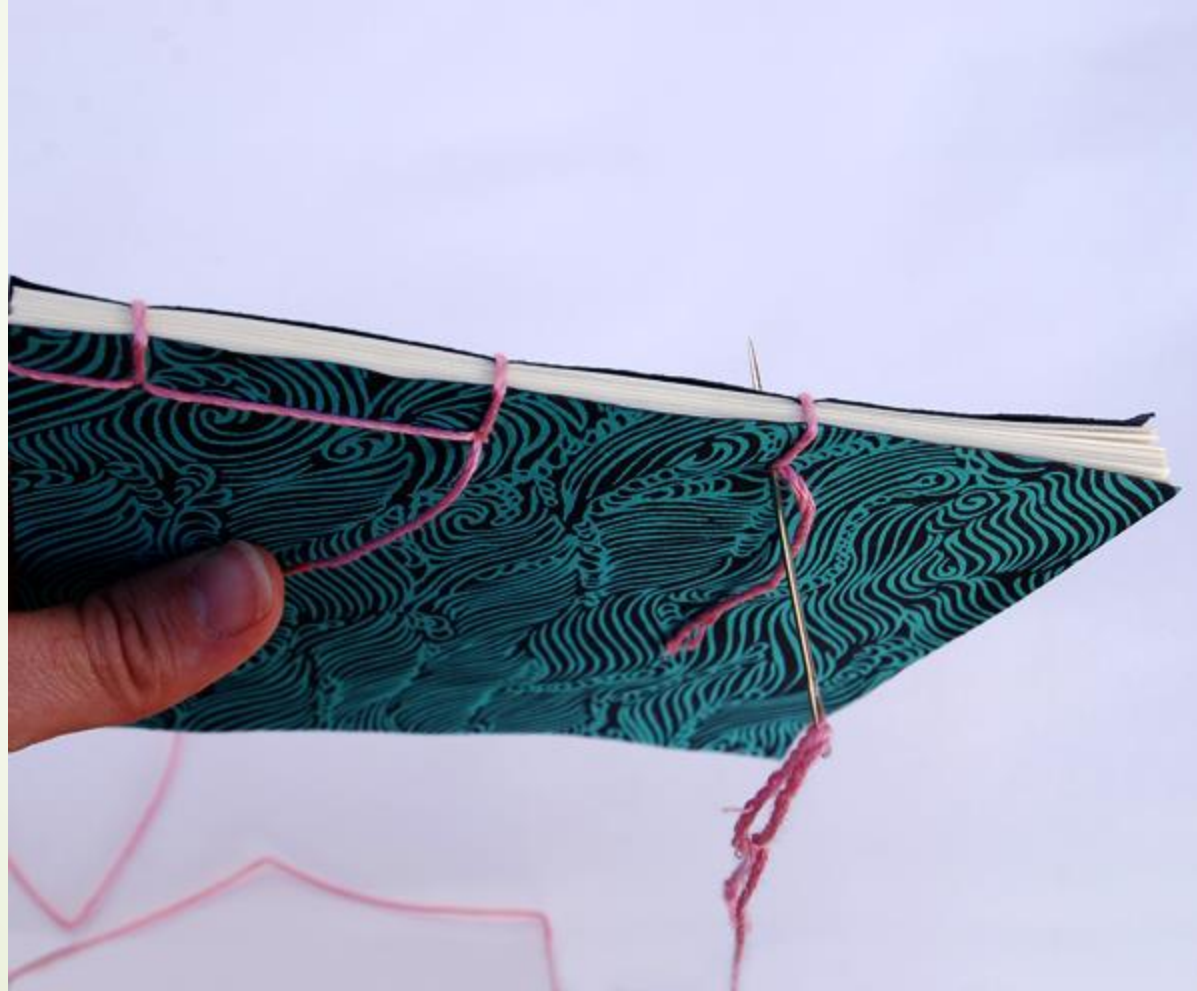

Bind the Book

▶ Step 10

- ▶ Sew down through hole number 4 and make a loop by sewing down again through the same hole.

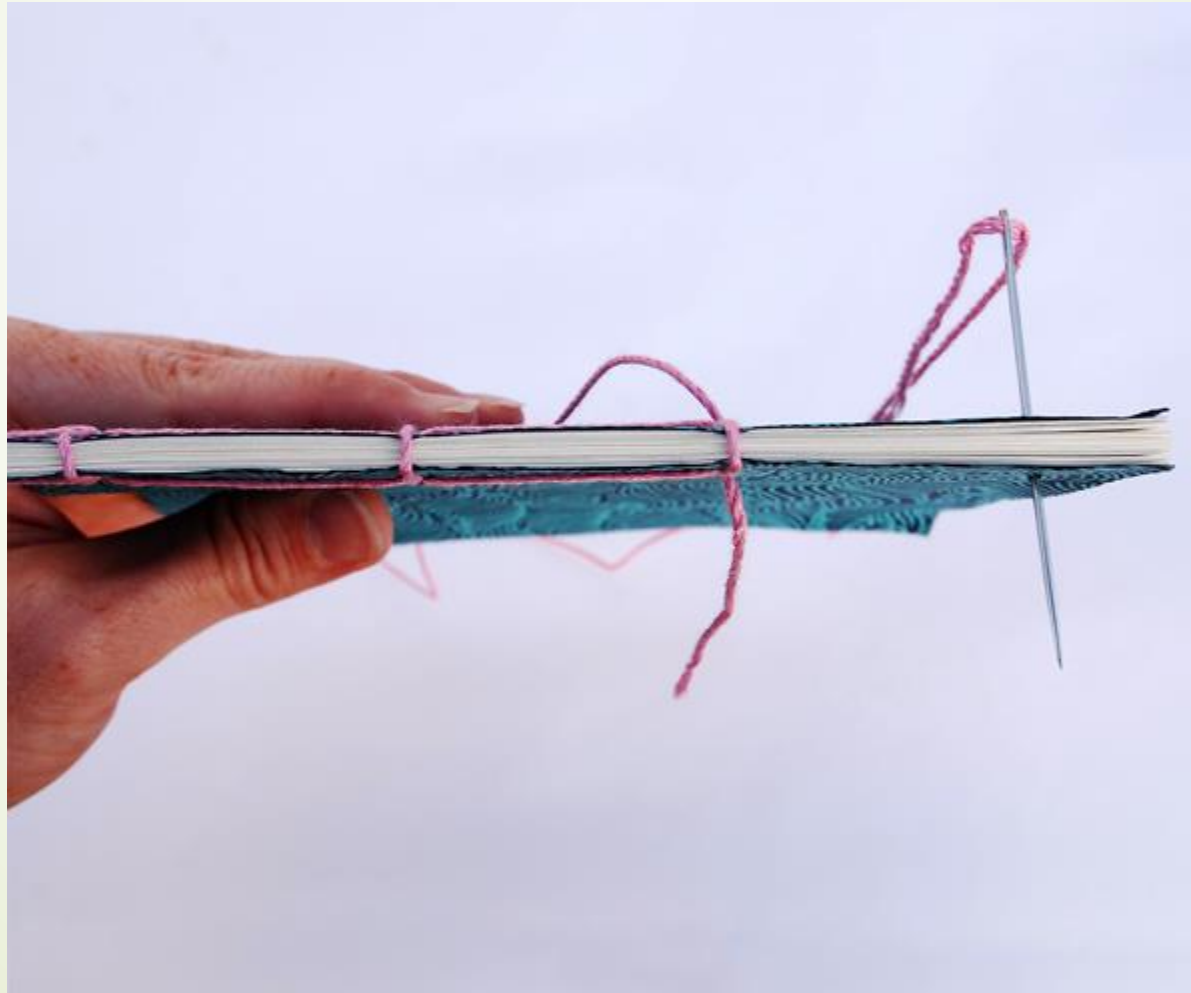

Bind the Book

▶ Step 10

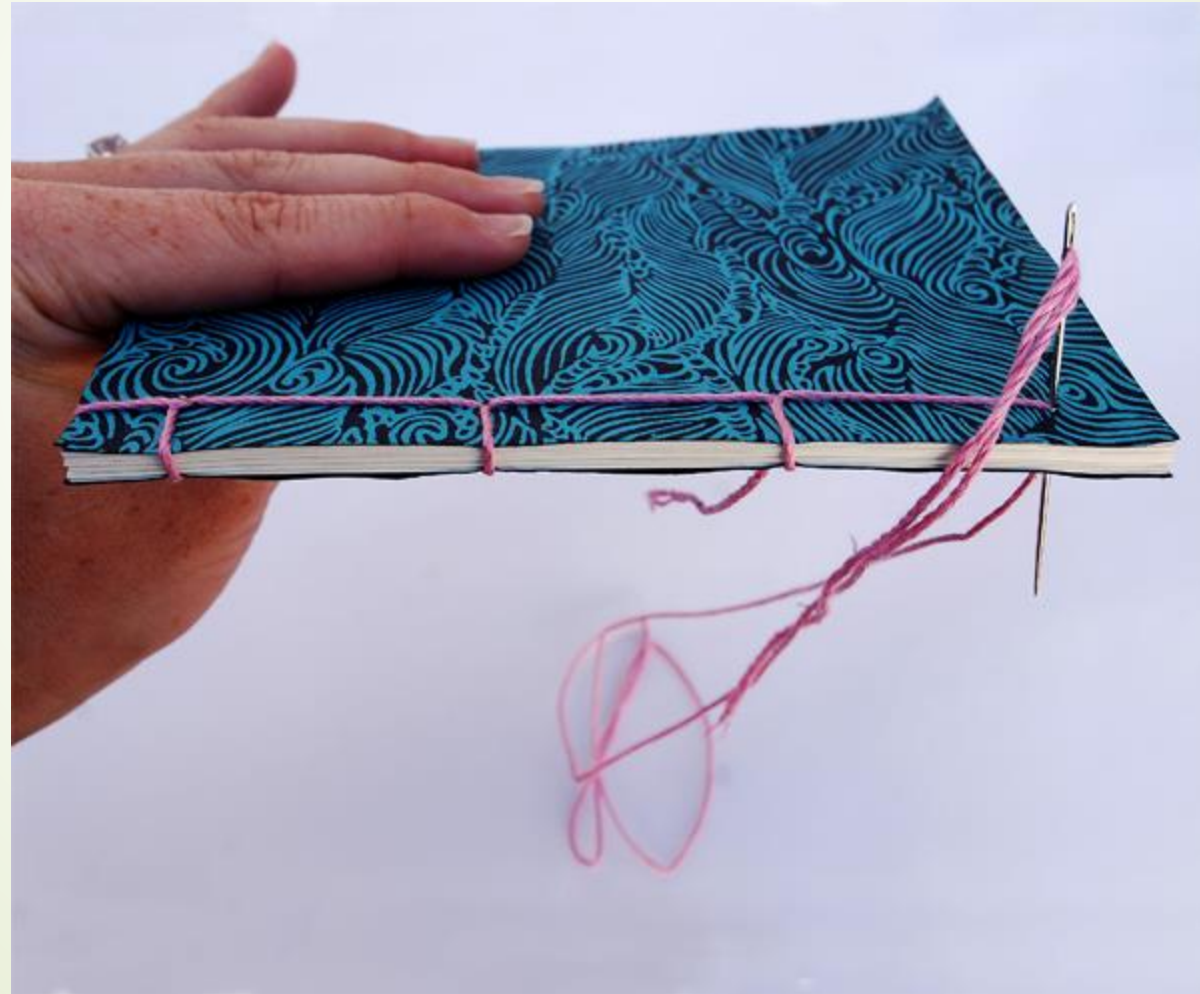

Bind the Book

▶ Step 11

- ▶ Make that second loop at the end of the binding by sewing down through hole number 4 one last time.



Bind the Book

▶ Step 12

- ▶ Now take a look at the back of the book where the tail end of your thread is sticking out.



Bind the Book

▶ Step 12

- ▶ Sew around the tail, moving the needle underneath the two surrounding stitches.



Bind the Book

▶ Step 13

- ▶ Tie a knot with the two ends of your thread.



Bind the Book

▶ Step 14

- ▶ Cut the excess thread and burnish the knot with your bone folder. This will help keep the knot from untying.



Bind the Book

▶ Step 14



All Done!

- ▶ Now that you've learned this basic technique, you can go on to learn more advanced bindings or even invent your own.

